

User Instructions

Gas-fired condensing combi appliance

Greenstar 2000

GR2301iW

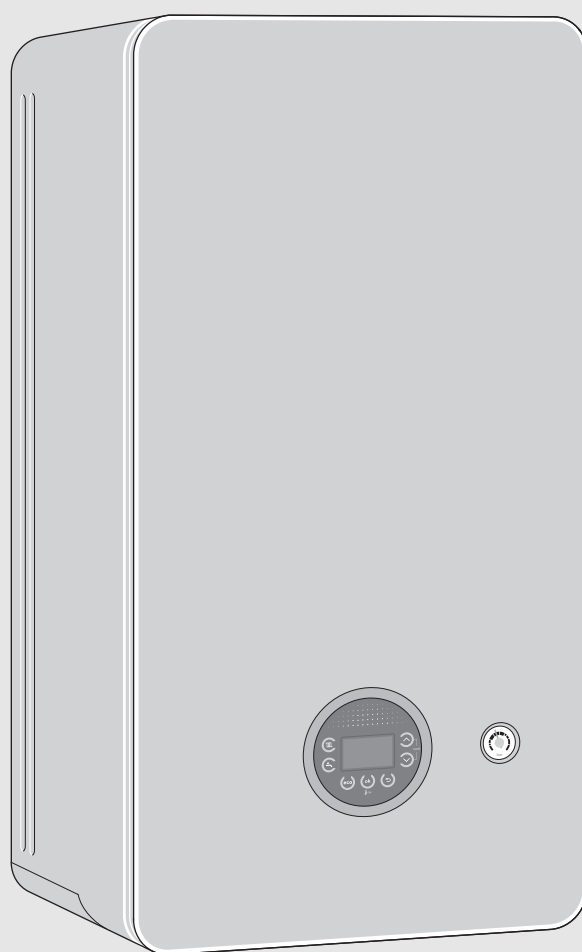

Preface

Dedicated to heating comfort.

Thank you for purchasing a Worcester product. We pride ourselves on manufacturing products to the strictest quality control standards throughout every stage of production.

Worcester, Bosch group has led the field in innovative product design and performance for over 50 years. This heritage means all our products are of exceptional quality and proven reliability.

Our products employ the latest technologies and they are reliable, extremely energy efficient, offering you economical running costs and value for money. They are amongst the top energy rated products available.

There is also the reassurance of our parts and labour guarantee. Our Customer Service team is here to help you get the best from your Worcester product throughout its lifetime. Whatever your enquiry, our specially trained team is available at our Worcester based contact centre and online via the website. For contact details see the back cover.

Table of contents

| | | |
|-----------|---|-----------|
| 1 | Explanation of symbols and safety instructions | 4 |
| 1.1 | Explanation of symbols | 4 |
| 1.2 | General safety instructions | 4 |
| 2 | Product Information | 6 |
| 2.1 | Appliance identification and serial number | 6 |
| 2.2 | Servicing | 6 |
| 2.3 | Maintaining your appliance | 6 |
| 2.4 | Benchmark standard | 6 |
| 3 | Prepare for operation | 7 |
| 3.1 | Sealed heating system | 7 |
| 3.1.1 | Checking the system pressure | 7 |
| 3.1.2 | Low pressure indication | 7 |
| 3.1.3 | Constantly re-pressurising the system | 7 |
| 3.2 | Topping up the system pressure | 8 |
| 4 | Operation | 9 |
| 4.1 | Switching on/off the appliance | 9 |
| 4.2 | Control panel overview | 10 |
| 4.3 | Screen display | 10 |
| 4.4 | Setting the flow temperature | 11 |
| 4.5 | Setting the DHW heating | 11 |
| 4.5.1 | Set DHW temperature | 11 |
| 4.5.2 | Setting comfort mode or eco mode | 11 |
| 4.6 | Setting summer mode | 11 |
| 4.7 | Manual mode | 11 |
| 5 | Key (accessories) | 12 |
| 5.1 | Key LED | 12 |
| 6 | Shutdown | 12 |
| 6.1 | Setting frost protection | 12 |
| 7 | Clearances and ventilation information | 13 |
| 7.1 | Appliance clearances | 13 |
| 7.2 | Ventilation information | 14 |
| 8 | Malfunction or failure | 15 |
| 8.1 | Troubleshooting | 15 |
| 8.2 | Extreme cold weather | 16 |
| 9 | Environmental protection and disposal | 18 |
| 10 | Tips on energy saving | 19 |
| 11 | Your guarantee | 19 |
| 12 | Energy consumption | 20 |
| 12.1 | Product data on energy consumption | 20 |
| 13 | Data Protection Notice | 22 |

1 Explanation of symbols and safety instructions

1.1 Explanation of symbols

Warnings

In warnings, signal words at the beginning of a warning are used to indicate the type and seriousness of the ensuing risk if measures for minimising danger are not taken.

The following signal words are defined and can be used in this document:

DANGER

DANGER indicates that severe or life-threatening personal injury will occur.

WARNING

WARNING indicates that severe to life-threatening personal injury may occur.

CAUTION

CAUTION indicates that minor to medium personal injury may occur.

NOTICE

NOTICE indicates that material damage may occur.

Important information



The info symbol indicates important information where there is no risk to people or property.

Additional symbols

| Symbol | Meaning |
|--------|---|
| ▶ | a step in an action sequence |
| → | a reference to a related part in the document |
| • | a list entry |
| – | a list entry (second level) |

Table 1

1.2 General safety instructions

⚠ Notices for the target group

These operating instructions are intended for the heating system operator.

All instructions must be observed. Failure to comply with instructions may result in material damage and personal injury, including danger to life.

- ▶ Read and retain the operating instructions (heat source, heating controller, etc.) prior to operation.
- ▶ Observe the safety instructions and warnings.

⚠ Determined use

The product may only be used for the heating of boiler water and for DHW heating.

Any other use is considered inappropriate. We assume no liability for damage occurring due to non-permitted use.

⚠ If you smell gas

A gas leak could potentially cause an explosion. If you smell gas, observe the following rules:

- ▶ Prevent flames or sparks:
 - Do not smoke, use a lighter or strike matches.
 - Do not operate any electrical switches or unplug any equipment.
 - Do not use the telephone or ring doorbells.
- ▶ Turn off the gas at the meter or regulator.
- ▶ Open windows and doors.
- ▶ Warn your neighbours and leave the building.
- ▶ Prevent anyone from entering the building.
- ▶ Move well away from the building: call the National Gas Emergency Service on 0800 111 999.
- ▶ L.P.G. boilers: Call the supplier's number on the side of the gas tank.

⚠ Danger to life from poisoning by flue gas

There is a danger to life from escaping flue gas.

▶ Never modify any parts through which flue gas is routed.

If flues are damaged or leaking, or if you smell flue gas, observe the following rules.

- ▶ Switch off the heat source.
- ▶ Open doors and windows
- ▶ Warn your neighbours and leave the building immediately.
- ▶ Prevent third parties from entering the building.
- ▶ Notify an approved contractor.
- ▶ Have any defects rectified.

⚠ Danger to life from carbon monoxide

Carbon monoxide (CO) is a poisonous gas, which arises during the incomplete combustion of fossil fuels such as oil, gas or solid fuels.

Dangers arise, if carbon monoxide escapes from the heating system due to a fault or a leak and collects unnoticed in enclosed spaces.

You can neither see, taste nor smell carbon monoxide.

To avoid danger from carbon monoxide:

- ▶ Have the heating system inspected and serviced regularly by an approved contractor.
- ▶ Use a CO detector, which gives an alarm in good time if CO escapes.
- ▶ If you suspect a CO leak:
 - Warn your neighbours and leave the building immediately.
 - Call an approved contractor.
 - Have any defects rectified.

⚠ Inspection, cleaning and maintenance

The user is responsible for ensuring the heating system is safe and environmentally compatible.

Non-existent or improper inspection, cleaning and maintenance may result in personal injury, including danger to life or material damage.

We recommend that you enter into a contract covering an annual inspection and responsive cleaning and maintenance with an approved contractor.

- ▶ Have work carried out only by an approved contractor.
- ▶ Have the appliance and heating system inspected by an approved contractor at least once a year.
- ▶ Have any required cleaning or maintenance work carried out immediately.
- ▶ Have any defects in the appliance and heating system remedied immediately, independent of the annual inspection.

⚠ Fittings and modification

Only a competent engineer can remove the appliance case and carry out any work, in accordance with the relevant Installation Regulations.

Any misuse or unauthorised modifications to the appliance, flue or associated accessories and heating system will invalidate the guarantee.

- ▶ Do not modify the appliance or flue system in any way.

Worcester, Bosch Group accepts no liability arising from any such actions. This does not affect your statutory rights.

⚠ Combustion air/ambient air

The air in the installation location must be free of flammable or chemically aggressive substances.

- ▶ Do not store or use any flammable or explosive materials (paper, petrol, thinners, paints, etc.) in the vicinity of the heat source.
- ▶ Do not store or use any corrosive substances (solvents, adhesives, chlorinated cleaning agents, etc.) in the vicinity of the heat source.

⚠ General considerations

- ▶ The boiler must be installed in a well ventilated area. The openings must be kept in good condition.
- ▶ The vents or any other component contributing to the functioning of the boiler must not be reduced or sealed.
- ▶ We recommend an annual service of the appliance by an approved engineer to ensure reliable and efficient operation.

⚠ Safety of electrical devices for domestic use and similar purposes

The following requirements apply in accordance with EN 60335-1 in order to prevent hazards from occurring when using electrical appliances:

“This appliance can be used by children of 8 years and older, as well as by people with reduced physical, sensory or mental capabilities or lacking in experience and knowledge, if they are supervised and have been given instruction in the safe use of the appliance and understand the resulting dangers. Children shall not play with the appliance. Cleaning and user maintenance must not be performed by children without supervision.”

“If the power cable is damaged, it must be replaced by the manufacturer, its customer service department or a similarly qualified person, so that risks are avoided.”

⚠ Please read these instructions carefully

- ▶ These instructions are applicable to the Worcester appliance models stated on the front cover only.
- ▶ These instructions apply in the UK/IE only and must be followed except for any statutory obligation.

2 Product Information

2.1 Appliance identification and serial number

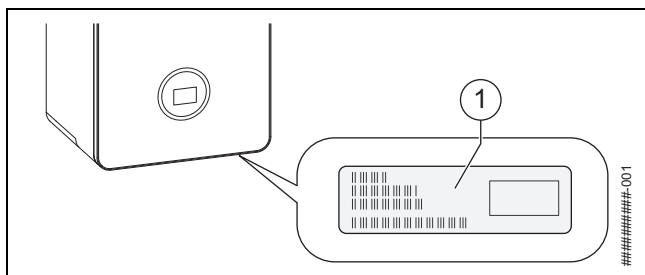

Fig. 1 Position of data label

The data label [1] contains information of the appliance model and serial number. This is located centrally on the bottom of the appliance in line with the control panel.

For your own records

Please ensure that the Commissioning Checklist has been completed by your installer or service engineer.

| | |
|-----------------------|--|
| Model: | |
| Serial number: | |
| Date of installation: | |

Table 2 Appliance details

The appliance model and serial number can be found on the appliance data label.

2.2 Servicing



Ensure that the service engineer completes the Service Record in the Benchmark Checklist after each service.

The Service Record can be found at the rear of the appliance's Installation and Maintenance Instructions. It will be required in the event of any guarantee work and may be required by the local Building Control Inspector.

- ▶ To ensure the continued safe, reliable and environmentally optimum operation of the boiler, it must be thoroughly serviced annually by a competent, qualified person, such as a Worcester service engineer, British Gas engineer or other Gas Safe registered engineer. In the Republic of Ireland servicing work must be carried out by a Worcester service engineer or other Registered Gas Installer (RGII).
 - Having a contract covering annual servicing, cleaning and maintenance is a good way to ensure this is not missed.
 - It is important that any required maintenance or repairs are carried out without delay.
- ▶ Ensure that the service engineer completes the Service Record, at the rear of the Installation and Maintenance Instructions manual, after each service.
- ▶ Have any work carried out by a competent, qualified person, Worcester service engineer, British Gas engineer or other Gas Safe registered engineer. In the Republic of Ireland servicing work must be carried out by a Worcester service engineer or other Registered Gas Installer (RGII).
- ▶ Always use original spares, to help maintain the efficiency, safety and reliability of the appliance.

2.3 Maintaining your appliance

Your new appliance represents a long term investment in a reliable, high quality product.

Wipe the appliance casing with a soft clean cloth. Please do not use chemical cleaning products which may damage the paint finish.

In order to realise the appliance's maximum working life, and to ensure the appliance continues to operate at peak efficiency and performance, it is essential that servicing and maintenance checks are performed at least once a year by a competent engineer in accordance with the current Gas Safe Regulations.

If you would like to know more about servicing options from Worcester, Bosch Group, please visit worcester-bosch.co.uk.

Please tick the appropriate box on your warranty registration card for further details of the Worcester, Bosch Group Service Contract.

When your appliance requires servicing please contact a Worcester, Bosch Group contact centre (see rear cover, appointments).

In addition to the service contract we are pleased to offer a one-off annual service or breakdown call out for your appliance.

Maintenance tips

- Appliances on a sealed heating system:
 - Regularly check the system pressure.
- Do not obstruct the flue outlet or the air inlet.
- Use in hard water areas:
 - In exceptionally hard water areas a device to prevent scale formation should be fitted. Installation of a salt based water softener should be in accordance with the requirements of the local water company. A bypass valve must be fitted and used to fill/top up the heating system with untreated water.



Important note:

- ▶ If you have to add water regularly in your heating system, call a competent, qualified person.

2.4 Benchmark standard



The Benchmark initiative is a code of practice to encourage the correct installation, commissioning and servicing of domestic central heating appliances and system equipment.

A "checklist" is dispatched with every appliance and can be found towards the back of the Installation, Commissioning and Servicing Instructions. This is a vital document that needs to be completed by the installer at the time of installation. It confirms that the appliance has been installed and commissioned according to the manufacturer's instructions.

The service record provides space for the recording of regular servicing of the appliance/heating system and this can become a valuable document when, for example, you wish to sell the property. The service record will show a potential purchaser that the heating system has received regular professional maintenance and servicing during its lifetime.

The Benchmark initiative aims to:

- Raise standards among professional installers.
- Build and maintain high safety standards in the industry.
- Improve customer satisfaction levels.
- Make a contribution to the nation's commitment to climate change.

3 Prepare for operation

3.1 Sealed heating system

Appliances that can be connected to sealed heating systems are pre-pressurised before operation, this pressure must be maintained for safe use of the appliance.

- ▶ Check regularly that the pressure is maintained.
- ▶ Re-charge the system if the pressure indicator reads less than 0.8 bar.
- ▶ If a permanent significant decrease or increase in pressure is shown on the pressure indicator, contact your installer or maintenance engineer.



Pressure indicator

- ▶ Type of pressure indicator for the system pressure.
 - Pressure gauge (an analogue dial showing the pressure)
 - Pressure menu (a digital readout of the pressure)
- ▶ Your appliance may have one or both types of methods to indicate the system pressure. The type of method used on this appliance will be detailed in the following section.

3.1.1 Checking the system pressure

Your installer will advise you of the optimum operating pressure.

- ▶ Check the system pressure on the pressure gauge.
 - **Static pressure** is when appliance is cold and has not fired for heating or hot water. This will generally be 1 - 1.5 bar.
 - **Operating pressure** is when the appliance is firing for a heating or hot water demand. This will generally be 1 - 2 bar.
- ▶ Top up the heating water, if the pressure is too low.

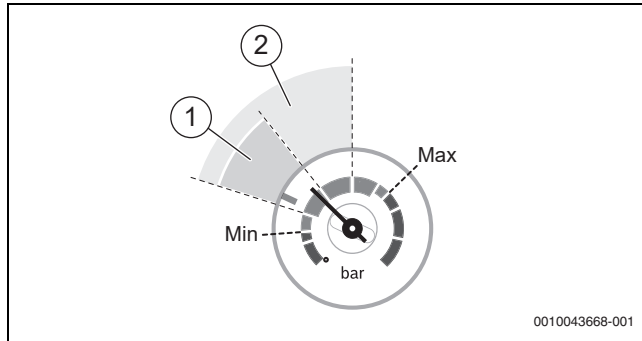

Fig. 2 Pressure gauge for checking the operating pressure

- [1] Static pressure range
- [2] Operating pressure range

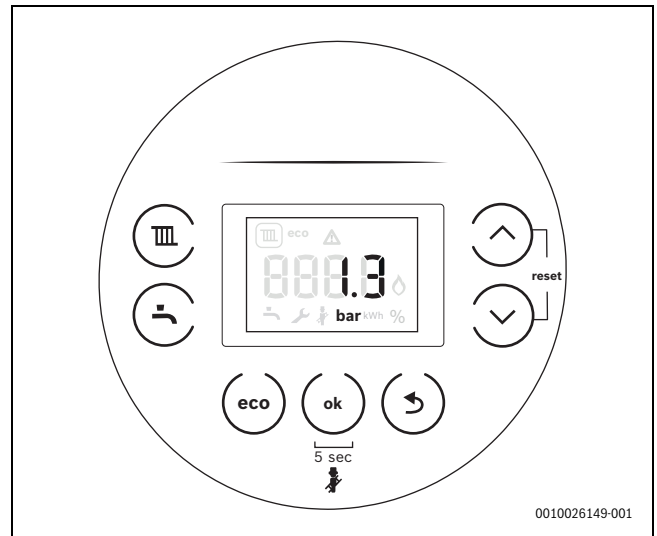

Fig. 3 Actual pressure

Your installer will advise you of the optimum operating pressure.

- ▶ Press the **ok** key.
The actual pressure appears.

3.1.2 Low pressure indication

Low pressure (shaded area [A]) will be indicated on the appliance:

- The needle is within the area between 0 and 1bar.

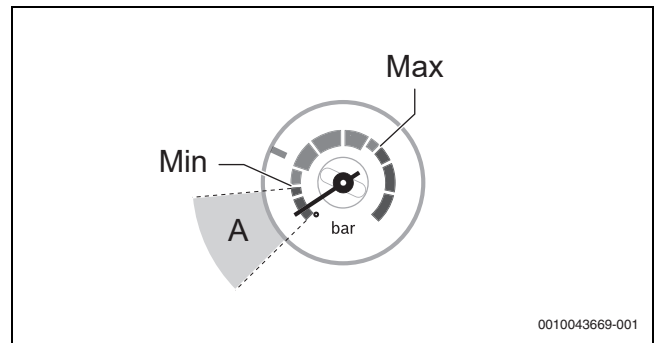

Fig. 4 Low pressure indication

[A] Low pressure area

Low pressure warning of the heating system via HMI

| | |
|--|---|
| | Displayed when system pressure is lower than 1.1 bar. |
|--|---|

Table 3

3.1.3 Constantly re-pressurising the system

Constantly having to re-pressurise the heating system should be investigated as it is an indicator of potential leaks and the concentration of inhibitor protection in the system will be reduced; this can result in corrosion within the heating system, reducing efficiency and increasing contaminates.

- ▶ Check for leaks on heating system (pipework and radiator valves).
- ▶ Contact your installer or maintenance engineer if a recurring significant decrease or increase in pressure is shown on the pressure indicator (pressure gauge or pressure display).

System pressure increasing:

- ▶ If the system pressure repeatedly increases and you need to vent air from the radiators, refer to → section "System gassing", page 17.

3.2 Topping up the system pressure



Your installer should have informed you where to find the filling system and instructed you in its use.

NOTICE

System fill method

- ▶ You must disconnect the external filling loop after re-pressurisation, to comply with the Water Authority regulations.

External filling loop

Once the external filling loop and pressure gauge has been located, follow the instructions for re-pressurising the system.

Refer to figure 5.

- ▶ Unscrew the blanking cap [1].
- ▶ Attach the hose [2] to the valve.
 - Usually one end of the hose is already connected to one of the system fill isolation valves.
- ▶ Ensure both ends [3] of the hose are screwed on hand tight.
 - The system fill isolation valves [4] are in a closed position (the handle/screwdriver slot is across the valve).
- ▶ Turn the handle/screwdriver slot through 90° to open valves and slowly fill the system to between 1 and 1.5 bar.
 - The system fill isolation valves [5] are opened (the handle/screwdriver slot is in-line with the valve).
 - The needle on the pressure gauge will start to rise.
- ▶ Turn the handles/screwdriver slots back, through 90°, to close the valves.
 - The system fill isolation valves [6] are in a closed position (the handle/screwdriver slot is across the valve).
- ▶ Top up the system pressure, if as a result of the air bleeding the pressure drops off.
- ▶ Remove the hose [2] and replace the blanking cap [1].

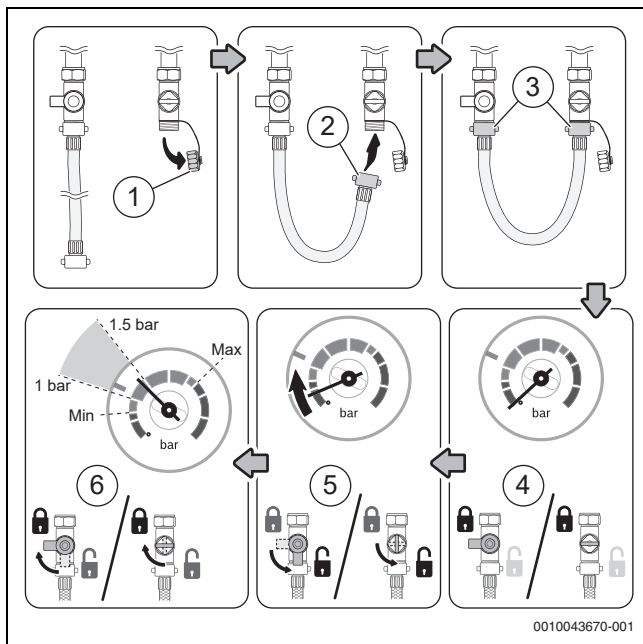

Fig. 5 External filling loop

Keyless filling link (optional accessory)

Locate the filling link (underneath the appliance on the right hand side) and follow the instructions for re-pressurising the system.

Re-pressurise the system.

- ▶ To start the filling process, pull the lever [1] down.
 - The needle on the pressure gauge will start to rise.
- ▶ To stop the filling process, release the lever [1] when:
 - The pressure, shown on the pressure gauge, reaches between the 1 and 1.5 bar [2].
- ▶ Top up the system pressure, if as a result of the air bleeding, the pressure drops off.

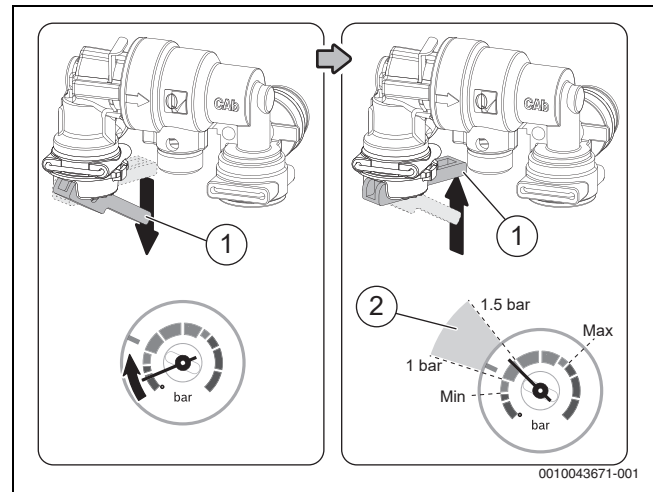

Fig. 6 Keyless filling link



If the pressure gauge reads more than 1.5 bar as a result of over filling:

- ▶ Bleed one radiator until the pressure gauge returns to between 1 and 1.5 bar.
- ▶ It is good practice to bleed any excess air that has entered the heating system due to pressure loss. Locate and open the radiator's bleed/vent point, closing the valve when water begins to flow.
- ▶ If, through normal boiler operation, the PRV pipe starts to leak, it could be a sign of system pressure being too high. In this instance please bleed a radiator as described above.

WARNING

Risk of damage to the system from corrosion!

If the pressure in your heating system is repeatedly rising and you are repeatedly venting radiators, this can indicate that there is corrosion occurring within the heating system.

To prevent serious damage to the entire system:

- ▶ Contact a heating engineer.



Failure to properly maintain the heating system may affect your warranty.



System pressure can be checked via the boiler's pressure gauge/reading when the system is cold, ensuring the reading is in the green zone at all times.

CAUTION

Caution must be exercised when venting radiators or re-pressurising/topping up the heating system:

- ▶ Do not vent air from radiators whilst the central heating is switched on.
- ▶ Allow 30 minutes after venting the radiators before using central heating or hot water.
- ▶ Whilst venting radiators, do not allow the pressure to drop below the green zone on the boiler's pressure gauge/reading.



If symptoms persist:

- ▶ Do not repeatedly vent your radiators.
- ▶ Contact a heating engineer.

4 Operation

These operating instructions describe the operation of the gas-fired condensing boiler. Therefore please also observe the operating instructions for the user interface.

4.1 Switching on/off the appliance

Switching on

After initial power-up of the appliance, the appliance will initiate siphon fill mode.



When  and the flow temperature appear alternately on the display, the appliance remains at minimum heat output for 15 minutes to fill the condensate trap.

Switching off

NOTICE

Risk of damage to the system from frost!

The heating system can freeze after a prolonged period (e.g. during a power failure, switching off the power supply, faulty fuel supply, appliance fault etc.).

- ▶ Ensure that the heating system is in constant use (particularly when there is a risk of frost).

Frost protection for the heating system is only ensured if the heating pump is operational and is pumping heating water through the entire system. If you are leaving your property unoccupied during cold weather, please:

- ▶ Leave the heating switched on.
- ▶ Set the time control to constant ON and set the room thermostat to 12 °C.



The anti-seizing function is not active when the appliance is switched off.

The anti-seizing function prevents the heating pump and the diverter valve from seizing up following long periods of inactivity.

4.2 Control panel overview

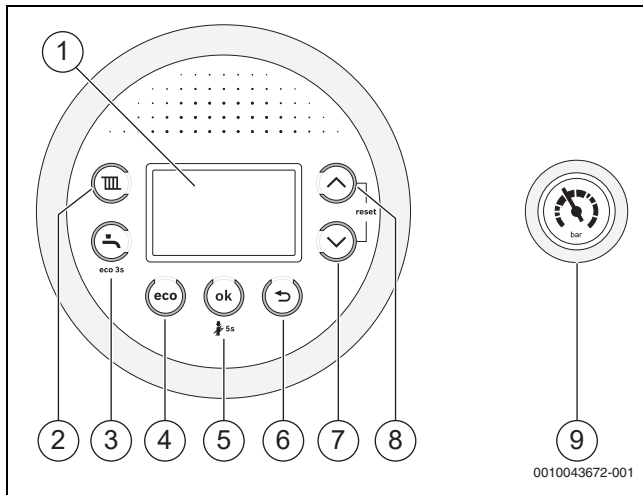

Fig. 7

- [1] Display
- [2] : Heating mode on/off, set the maximum flow temperature
- [3] : Hot water mode, adjusting the hot water temperature
- [4] **eco**: Turn economy mode on or off (see → 4.5.2, page 11)
- [5] **ok**: Save settings
- [6] : Return/back
- [7] : To navigate through menus and decrease settings
- [8] : To navigate through menus and increase settings
- [9] Pressure gauge

4.3 Screen display

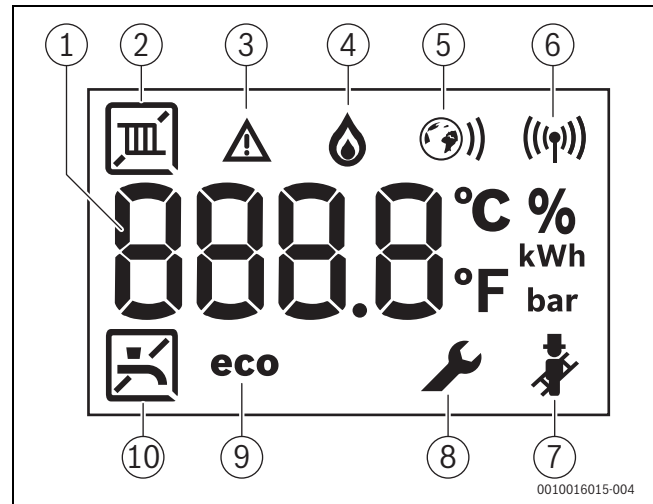

Fig. 8 Screen display

| Key | Explanation |
|------|---|
| [1] | Digital display <ul style="list-style-type: none"> • Displays a temperature or appliance status/diagnostic code. |
| [2] | Central heating (CH) <ul style="list-style-type: none"> • Heating mode On • Heating mode Off |
| [3] | Fault indicator <ul style="list-style-type: none"> • Displays during a fault condition. |
| [4] | Burner operation <ul style="list-style-type: none"> • Displays when the appliance is firing during a heating or hot water mode. |
| [5] | Internet connected (accessory) <ul style="list-style-type: none"> • Displays when compatible controller is connected to the appliance (not used). |
| [6] | Radio link connected (accessory) <ul style="list-style-type: none"> • Displays when compatible controller is connected to the appliance. |
| [7] | Chimney sweep mode <ul style="list-style-type: none"> • Displays during service when the appliance is set to maximum or minimum output. Only to be operated by a qualified heating engineer. |
| [8] | Service mode <ul style="list-style-type: none"> • Displays when a qualified service engineer is in the service menus. |
| [9] | Eco mode active <ul style="list-style-type: none"> • Displays when in Economy mode (when in Eco mode, comfort mode is turned off) |
| [10] | Domestic hot water (DHW) <ul style="list-style-type: none"> • Hot water mode On • Hot water mode Off |

Table 4



The heating and hot water system has been set up by the installer to its optimum settings.

- It is advised to make a note of these settings before adjusting so that you can return to these optimum settings in the future.

4.4 Setting the flow temperature

The maximum flow temperature can be adjusted between 30 °C and 82 °C. The current flow temperature is shown on the display.

- ▶ Press the **III** key.
The set maximum flow temperature is displayed.
- ▶ Press arrow key **▲** or **▼** to set the required maximum flow temperature.
- ▶ Press the **ok** key to save. Otherwise the setting will be saved automatically after 3 seconds.
The display shows the current flow temperature.

The **III** symbol flashes in the display in heating mode. The **🔥** symbol also appears if the burner is active.

! WARNING

Risk of scalding!

- ▶ This appliance is supplied with the CH control set at approximately 65 °C, a temperature that should be suitable for most installations that comply with the current building regulations. When the boiler switches from CH to DHW, the temperature of the hot water may briefly exceed the DHW set point if the CH temperature is set higher than the DHW temperature. If the CH temperature is changed to above 65 °C, it is advisable to fit a thermostatic mixing valve (TMV) at the point of use (e.g. before the bath hot tap or shower) to protect vulnerable people from scalding.

4.5 Setting the DHW heating

4.5.1 Set DHW temperature

DHW temperature:

- ▶ Press the **🔧** key.
The set DHW temperature is displayed.
- ▶ Press arrow key **▲** or **▼** to set the required DHW temperature
- ▶ Press the **ok** key to save. Otherwise the setting will be saved automatically after 3 seconds.
The display shows the current flow temperature.

The **🔧** symbol flashes in the display in DHW mode. The **🔥** symbol also appears if the burner is active.

4.5.2 Setting comfort mode or eco mode

In comfort mode, the appliance is continually maintained at the set temperature. This means there will be a shorter delay between opening a hot tap and receiving hot water. However, the appliance will use more gas in comfort (or pre-heat) mode.

In eco mode, heating-up to the set temperature begins as soon as the hot water tap has been opened.

- ▶ To set eco mode: press **eco** until **eco** appears in the display.
- ▶ To return to comfort mode: press the **eco** key until **eco** vanishes from the display.

i

In eco mode, to reduce water usage:

- ▶ Briefly open and close the DHW tap.
The water is heated once to the set temperature.

4.6 Setting summer mode

The heating pump and consequently the heating are switched off in summer mode. The DHW supply and also the power supply for heating controls and timer remain active.

NOTICE

Risk of the system freezing.

Frost protection is not available in summer mode.

- ▶ If there is a risk of frost, exit summer mode (→ Chapter 6.1).

To activate summer mode:

- ▶ Press the **III** key.
- ▶ Keep pressing the arrow key **▼** until **OFF** appears in the display.
- ▶ Press the **OK** key to save. Otherwise the setting will be saved automatically after 3 seconds.
III is permanently displayed.

Further notices can be found in the operating instructions for the heating control.

4.7 Manual mode

Manual mode can be enabled to operate the boiler independent of controls, should there be a technical issue with time and temperature controls fitted.

To activate manual mode:

- ▶ Press and hold the **III** key for 5 seconds.
- ▶ Check the flow temperature shown and adjust if necessary.
 - The flow temperature will be shown in between two hyphens, indicating manual mode.

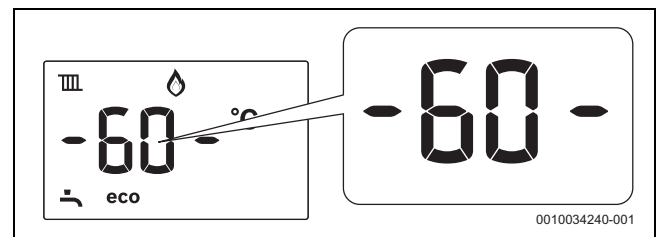

Fig. 9 Manual mode shown on display

i

Manual mode should be used for a limited time only until the time and temperature controls are fixed. It is highly likely that increased gas consumption will occur during manual mode.

- ▶ To disable Manual Mode press and hold the **III** key for 5 seconds.

5 Key (accessories)

5.1 Key LED



Key accessory location

- ▶ The Key can be located underneath the appliance on the right hand side.

Key LED status

The LED on the Key displays different states with flashing or constant colours.



| Description of the LED displays | Example |
|--|---|
| Flashing red: Fault, e.g. no communication between the Key and appliance: ▶ Install the Key again, restore the last functioning status. |  |
| Flashing yellow: No fault, user please wait. | |
| Flashing green: No fault, initialisation process is running. | |
| Constant red: Temporary fault: ▶ Wait for normal operating condition to be resumed. |  |
| Constant yellow: ▶ Keys with touch-sensitive indicator: Press touch-sensitive indicator on Key to start pairing. | |
| Constant green: No fault, normal operating condition. | |
| LED Off: No fault, power-saving mode or appliance without power. |  |

Table 5 LED status

For more information please refer to your control manual.

6 Shutdown

6.1 Setting frost protection

NOTICE

Risk of damage to the system from frost!

The heating system can freeze up after a prolonged period (e.g. during a power failure, switching off the power supply, faulty fuel supply, boiler fault etc.).

- ▶ Ensure that the heating system is in constant use (particularly when there is a risk of frost).

If you are leaving your property unoccupied during cold weather, please leave your external programmer on constant and your room thermostat set to 12 °C.

7 Clearances and ventilation information

7.1 Appliance clearances

Your installer will have provided adequate space around the appliance for operation, safety and servicing/maintenance access.

- The following detail the necessary clearance around the appliance for service and maintenance.

! WARNING

Risk of injury due to damage to the boiler

- Heat-producing kitchen appliances must not be operated directly underneath the boiler.

! CAUTION

Risk of damage to appliance or property

The appliance will overheat if the clearance space around the appliance is restricted by objects.

- Do not restrict this space with the addition of cupboards, shelves etc. next to or around the appliance.
- Do not store any combustible materials on or next to the appliance, such as clothes, towels, paper or plastic bags.

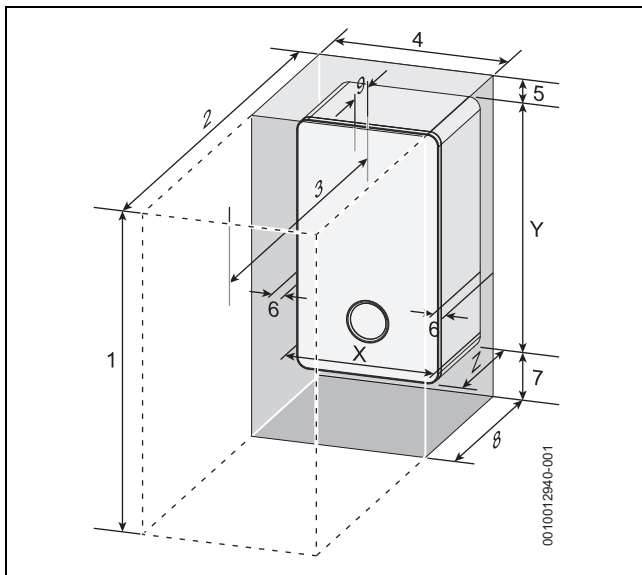

Fig. 10 Appliance minimum clearances

| Minimum clearances | | |
|--------------------|-----------------------------|-------------------------|
| | Description | Dimensions (mm) |
| X | Appliance width | 400 |
| Y | Appliance height | 724 ¹⁾ |
| Z | Appliance depth | 300 |
| Maintenance | | |
| 1 | Overall clearance height | 1094/1134 ²⁾ |
| 2 | Overall clearance depth | 900 ³⁾ |
| 3 | In front of appliance | 600 ³⁾ |
| 4 | Overall clearance width | 410 |
| 5 | Above the appliance | 170/210 ²⁾ |
| 6 | Either side of appliance | 5 |
| 7 | Below the appliance | 200 |
| 8 | Compartment depth | 320 ⁴⁾ |
| 9 | Appliance to removable door | 20 |

- Side panel height = 710mm.
- Height for either 60/100 flue or 80/125 flue.
- This can be reduced by 150mm (refer to Reduced front maintenance minimum clearances).
- Clearance to a combustible material.

Table 6 Appliance minimum clearances

Reduced front maintenance minimum clearances

The front servicing clearance for this appliance can be reduced to 450mm.

For installations with a front servicing clearance less than 600mm (minimum of 450mm), the following additional criteria must be achieved.

- The bottom of the appliance case must be between 1000mm and 1500mm from the floor.
- There must be at least 450mm clearance in front of the appliance to floor level. Anything sited below the appliance must not protrude into this clear space.
- There must be at least 200mm clearance to any structure which is sited below the appliance.
- There must be at least 300mm clear space to either the left hand or right hand side of the appliance. This clear space must be from the required clear height above the appliance to floor level.
 - This clearance will not apply if the appliance is sited within 300mm of a door way and the door frame is the only obstruction.



Minimum clearances must be observed to any obstruction/ surface, (dark shaded areas, figures 11 and 12).

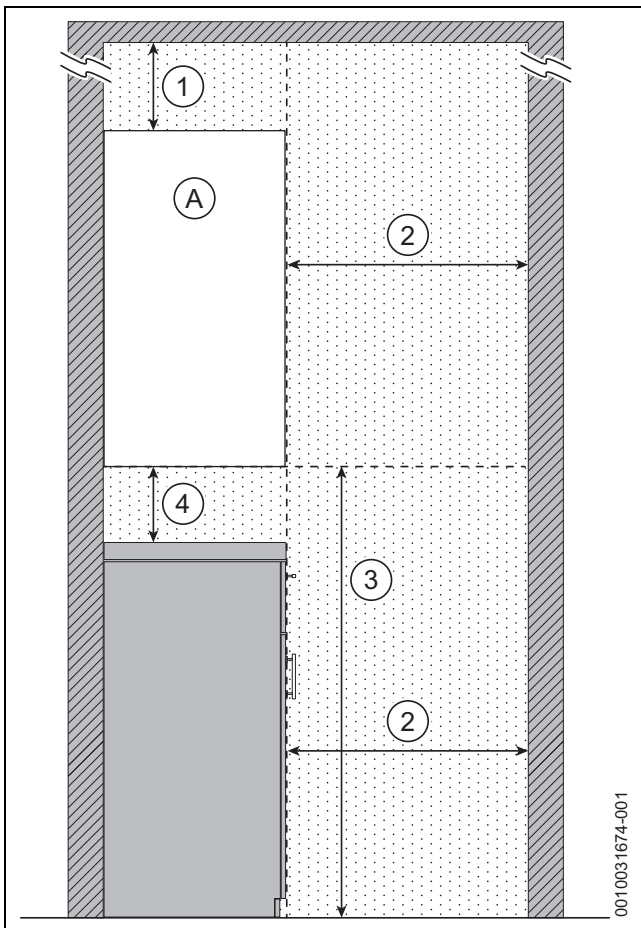

Fig. 11 Reduced front maintenance clearances - Side view

- [A] Appliance.
 [1] Above appliance - Same clearance required as for standard clearances of 60/100 flue or 80/125mm flue.
 [2] In front of appliance - Minimum 450mm.
 [3] Bottom of appliance to the floor - 1,000 - 1,500mm.
 [4] Below appliance - 200mm

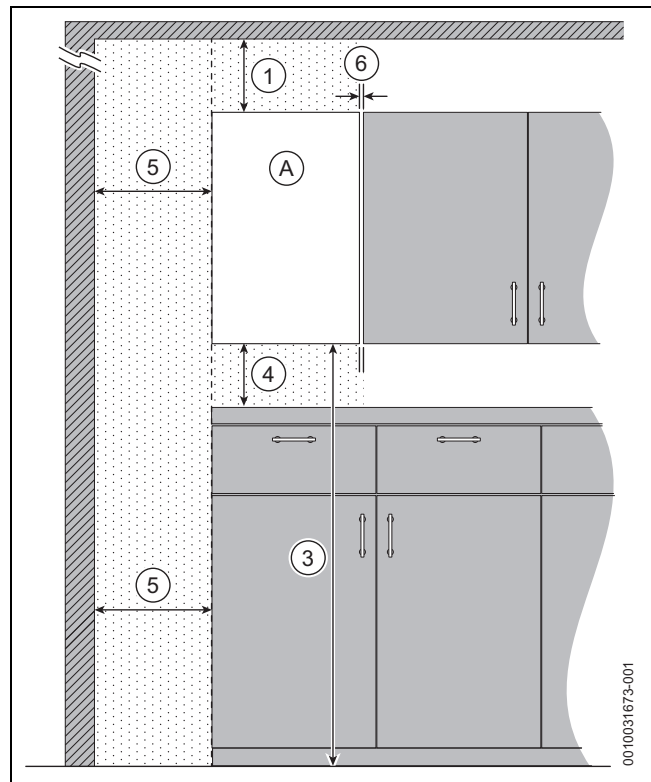

Fig. 12 Reduced front maintenance clearances - Front view

- [A] Appliance.
 [1] Above appliance - Same clearance required as for standard clearances of 60/100 flue or 80/125mm flue.
 [3] Bottom of appliance to the floor - 1,000 - 1,500mm.
 [4] Below appliance - 200mm
 [5] One side of appliance - Minimum 300mm.
 [6] One side of appliance - Minimum 5mm.

7.2 Ventilation information

The air supply must not be restricted or contaminated.



Ventilation considerations

- ▶ Do not place objects to hinder the air circulation required by the appliance.
- ▶ The installation premises may require ventilation to be fitted according to its features or use.

8 Malfunction or failure

If you believe there is a problem with your central heating or hot water supply, before you contact your installer/maintenance engineer and report the error and appliance type carry out the following checks.

Basic checks

Some items to check before placing a call are:

- Is the electrical power switched on to the appliance?
- Is the programmer/timer set to ON or in an ON period?
- Is the room thermostat set too low?
- Is the cylinder thermostat (if fitted) set too low?
- Is the cold water main turned on?
- Sealed heating system:
 - Is the static system pressure (when appliance is cold) between 1 and 1.5 bar?
- Do you have gas?
 - Are other gas appliances working, gas cooker/hob for example?
 - Has your credit run out on your gas pre-payment meter?

Details of your installer should be available in the Commissioning Checklist or can be recorded in the following section.

Installer/maintenance engineer

| Installer/maintenance engineer details | |
|--|--|
| Engineer name: | |
| Company name: | |
| Company address: | |
| Telephone: | |
| Email: | |

Table 7

Worcester, Bosch Group

The appliance is supported in the UK and Eire by Worcester, Bosch Group.

Specialist service engineers are available to attend an appliance breakdown.



Invoices for attendance and repair work carried out on this appliance by any third party will not be accepted.

- No charge will be made for parts and/or labour providing:
 - The appliance fault is found and the appliance is within the guarantee period. Reasonable evidence of this must be supplied on request. i.e. a completed Commissioning and service record and has been regularly serviced at least once a year.
- A call-out charge will be made where:
 - The appliance is outside the guarantee period or has not been serviced in accordance with the manufacturers instructions.
 - Our Field Service Engineer finds no fault with the appliance.
 - The cause of breakdown is misuse or with other parts of your plumbing/heating system, or with equipment not supplied by Worcester, Bosch Group.



No appliance fault is found on over 30% of all service calls.

- ▶ In the case of a suspected fault, refer to the basic checks earlier in this section.

In the event of an appliance fault or breakdown please contact Worcester, Bosch Group appointments team on 0330 123 9339. Your advisor will arrange for an engineer to call with the minimum of delay; under normal circumstances this will be from 1–3 working days (excluding weekends and bank holidays) for priority breakdown situations (no hot water and/or heating).

8.1 Troubleshooting

The  symbol indicates that a fault has occurred. The cause of the fault is displayed in code (e.g. fault code **214**).

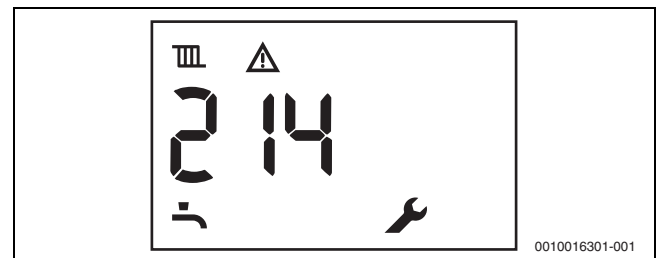





Fig. 13 Example of a fault code

Some faults lead to a shutdown of the appliance, which only starts again after a reset:

- ▶ Press the  and  arrows simultaneously, until the symbols  and  are no longer be displayed. The appliance starts up again. The flow temperature is displayed.

If a fault cannot be eliminated:

- ▶ Contact an Installer/Service Engineer or Worcester, Bosch Group appointments team on 0330 123 9339.
- ▶ You will need to provide them with the displayed fault code and the following appliance data.
 - Appliance type and serial number.
 - Commissioning date.

8.2 Extreme cold weather

In certain instances where the condensate pipework is run externally or in an unheated area, such as a garage, the condensate pipework can be at risk of freezing, even if well insulated.

A frozen/blocked condensate pipe will cause the boiler to shut down. Worcester, Bosch Group have available helpful videos on thawing frozen condensate pipe work on our website in the Customer Service section.



WARNING

Falling hazard!

Failure to follow this guidance may result in personal injury.

- ▶ Only attempt to thaw a condensate pipe that is at ground level and easily accessible.
- ▶ Never attempt to thaw a condensate pipe that is at height.



CAUTION

Risk of damage to pipe work!

Thermal shock from boiling water can damage plastic pipes.

- ▶ **DO NOT** use boiling water to thaw the condensate pipe!



CAUTION

Slip hazard

- ▶ Ensure that the subsequent freezing of any water does not result in a slip hazard.

If the condensate pipe has frozen:

- ▶ Locate the blockage.
 - It is likely that the pipe is frozen at the most exposed point outside the building or where there is an obstruction to flow. This could be the open end of the pipe, at a bend or elbow, or where there is a sag in the pipe in which condensate can collect.
 - The location of the blockage should be identified as closely as possible before taking further action.
- ▶ Thaw the frozen pipe.
 - The pipe can be thawed by applying a hot water bottle, a microwaveable heating pack (the sort used for muscular aches and pains) or a cloth soaked in hot water to the exterior of the pipe, close to the point of blockage.
 - Hot water, but not boiling, can also be poured onto the pipe from a watering can or similar container.
 - Care must be taken at pedestrian areas where this water may freeze and create a slip hazard.
- ▶ Worcester, Bosch Group have available on our website helpful videos in the Customer Service section to aid in thawing a frozen pipe.
- ▶ Reset the appliance and wait two or three minutes for the appliance to restart.
- ▶ Contact Worcester, Bosch Group Appointments Team on: 0330 123 9339, if the boiler does not restart.
- ▶ Contact your installer in order to find a permanent solution to the problem.

System gassing

WARNING

If you suspect the heating system is gassing, you must exercise caution when carrying out testing or remedial work as the gasses produced can be flammable. Do not vent air from radiators whilst the central heating is switched on. Allow 30mins after venting the radiators before using the central heating or hot water.

- ▶ Whilst venting radiators, do not allow the pressure on the boiler to drop below the point at which it is normally set.
- ▶ If the system is to be drained, the boiler must be electrically isolated.

CAUTION

If system pressure is repeatedly increasing, even when the appliance is not operating, you should first check that the filling link is fully closed and confirm that it is not passing. If radiators are also not heating to the top of the panels and repeatedly need venting, the heating system may be suffering from gassing. This is an indication that corrosion is taking place and requires the system being cleaned and treated to BS7593.

- ▶ This should be confirmed by taking water samples to check pH levels and turbidity.
- ▶ Failure to properly maintain the heating system may result in damage to the system and appliance, and may affect the boiler warranty.

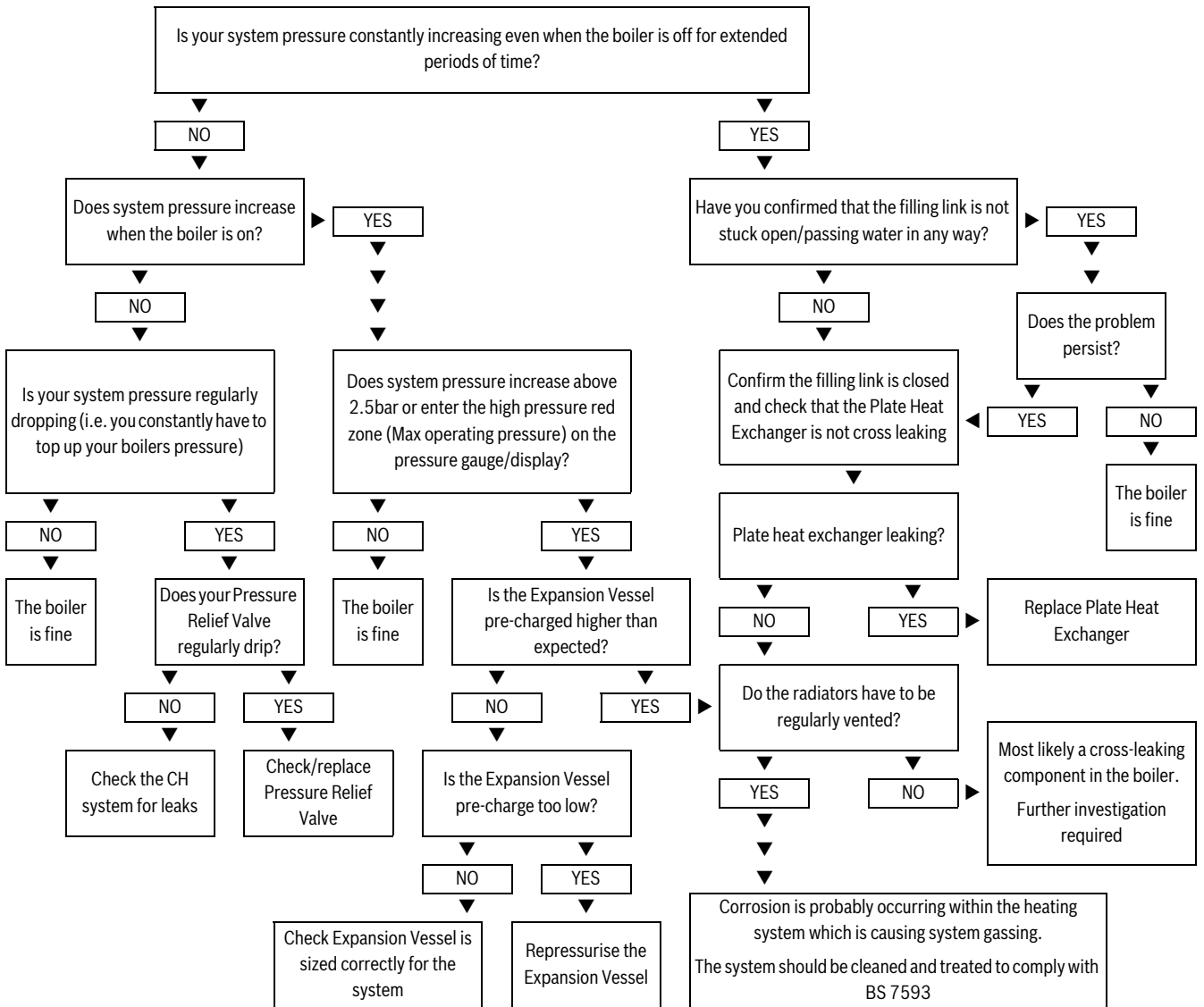

Table 8 System gassing flow chart

9 Environmental protection and disposal

Environmental protection is a fundamental corporate strategy of the Bosch Group.

The quality of our products, their economy and environmental safety are all of equal importance to us and all environmental protection legislation and regulations are strictly observed.

We use the best possible technology and materials for protecting the environment taking account of economic considerations.

Packaging

Where packaging is concerned, we participate in country-specific recycling processes that ensure optimum recycling.

All of our packaging materials are environmentally compatible and can be recycled.

Compostable packaging

Compostable packaging is used wherever possible in an effort to reduce the product's impact on the environment and the overall demand for plastic packaging. Where the following symbol is shown the material is compostable:



Compostable packaging can be disposed of in a number of ways:

- Home compost heap
- Local Authority garden waste collection
- Local Authority food waste collection, ideally as a food waste bin bag
- Local Authority household waste

Please note that compostable materials **cannot be recycled**.



Used appliances

Used appliances contain valuable materials that can be recycled.

The various assemblies can be easily dismantled. Synthetic materials are marked accordingly. Assemblies can therefore be sorted by composition and passed on for recycling or disposal.

Old electrical and electronic appliances



This symbol means that the product must not be disposed of with other waste, and instead must be taken to the waste collection points for treatment, collection, recycling and disposal.

The symbol is valid in countries where waste electrical and electronic equipment regulations apply, e.g. "(UK) Waste Electrical and Electronic Equipment Regulations 2013 (as amended)". These regulations define the framework for the return and recycling of old electronic appliances that apply in each country.

As electronic devices may contain hazardous substances, it needs to be recycled responsibly in order to minimize any potential harm to the environment and human health. Furthermore, recycling of electronic scrap helps preserve natural resources.

For additional information on the environmentally compatible disposal of old electrical and electronic appliances, please contact the relevant local authorities, your household waste disposal service or the retailer where you purchased the product.

You can find more information here:

www.bosch-homecomfortgroup.com/en/company/legal-topics/weee/

Batteries

Batteries must not be disposed together with your household waste. Used batteries must be disposed of in local collection systems.

10 Tips on energy saving

Quick Tap function

- ▶ Fully open your hot water tap for at least 3 seconds. This ignites the boiler.
- ▶ Turn hot water tap to fully closed.
- ▶ Wait up to 30 seconds¹⁾ as the boiler continues to prepare hot water.
- ▶ Open your hot water tap; hot water is available²⁾



On average, 3.5 litres of water can be saved when using the Quick Tap function.

Water saving varies depending on user behaviour, pipework design and the time of year, for example, if Central Heating is on during the winter, DHW will heat up quicker than in the summer, reducing the potential for water saving. Savings are calculated based on average mains water pressure, a heat-up time of 30 seconds and close proximity of the tap to the boiler.

Heating economically

The appliance provides a high level of comfort whilst keeping fuel consumption and the environment effects as low as possible.

The appliance is controlled in such a way that it delivers heat at the correct rate and only if there is a clear demand from the system.

Central heating systems with thermostatic radiator valves

With modern heating systems set around a 20 °C heat loss, the optimum setting for a condensing boiler will be approximately 65 °C for the central heating temperature. This is to ensure a return temperature of less than 52 °C.

The system must be balanced correctly and the radiators may need upgrading. This allows the boiler to condense as much as possible for the central heating system.

The temperature of each room can be set individually (except primary room with the room thermostat) using the thermostatic radiator valves.

Room thermostats

Reducing the setting of the room thermostat by 1 °C can reduce fuel consumption by up to 10%.

New control systems

Upgrade your heating control system if necessary with the latest equipment available.

Roof insulation

Around 30% of the heat loss from a property is through the roof. Replace any old insulation with new insulation, preferably of around 200mm thickness or more.

Window frames

Single glazed windows, particularly those with steel frames, can lose a great deal of heat. Consideration should be given to replacement with PVCu or wooden framed double glazed units.

Radiators

If a radiator is sited underneath a window, its performance will be affected if the curtains are allowed to drape over the radiator. Shelves fitted above or in front of the radiator should also be avoided.

It is advisable to manually adjust all thermostatic radiator valves every 2–3 months to prevent them sticking. Ensure radiator valves are correctly set and not damaged.

Draughts

Try to ensure that draughts around doors, windows, letter boxes and keyholes etc. are reduced by using a suitable draught excluder.



WARNING

Air vents!

- ▶ Do not block or seal any air vents that are installed to ensure that the appliance operates safely.

Curtains

Lined curtains, or heavier full length curtains can provide excellent insulation. However, always ensure that the curtains do not drape over radiators.

11 Your guarantee

This appliance has a guarantee against faulty materials or workmanship from the date of installation subject to the following terms and conditions:

- During the period of this guarantee any components of the appliance that are proven to be faulty or defective in manufacture will be exchanged or repaired free of charge by Bosch Thermotechnology Ltd.
- The householder may be asked to prove the date of installation, that the appliance was correctly commissioned and, where appropriate, serviced to the satisfaction of Bosch Thermotechnology Ltd. These should be documented in the commissioning and service records in the Installation and Maintenance Instructions.
- The appliance has been used only for the normal domestic purposes for which it was designed.

This guarantee does not affect your statutory rights.

Guarantee registration

Your appliance/product carries a guarantee against faulty material or manufacture subject to Terms and Conditions.

To read the full Terms & Conditions please visit us on-line at www.worcester-bosch.co.uk/guarantee.

Your statutory rights are not affected by the manufacturer's guarantee

1) If the hot water reaches the set temperature before 30 seconds has elapsed, the boiler will stop firing

2) Hot water is available at the boiler. Delivery time to the tap will vary on the pipework design and tap distance from the boiler

12 Energy consumption

12.1 Product data on energy consumption

The following product data comply with the requirements of the EU Regulations No. 811/2013, No. 812/2013, No. 813/2013 and No. 814/2013 supplementing the Regulation (EU) 2017/1369.

Natural Gas appliances

| Product data | Symbol | Unit | 7 736 902 326 | 7 736 902 325 |
|---|--------------------|--------|------------------|------------------|
| Product type | – | – | GR2301iW 25 C NG | GR2301iW 30 C NG |
| Condensing boiler | – | – | ✓ | ✓ |
| Low temperature boiler | – | – | ✗ | ✗ |
| B1 boiler | – | – | ✗ | ✗ |
| Cogeneration space heater | – | – | ✗ | ✗ |
| Equipped with a supplementary heater? | – | – | – | – |
| Combination heater | – | – | ✓ | ✓ |
| Rated heat output | P_{rated} | kW | 24 | 24 |
| Seasonal space heating energy efficiency | η_s | % | 94 | 94 |
| Energy Efficiency Class | – | – | A | A |
| Useful heat output | | | | |
| At rated heat output and high temperature regime ¹⁾ | P_4 | kW | 24 | 24 |
| At 30 % of rated heat output and low temperature regime ²⁾ | P_1 | kW | 8.1 | 8.1 |
| Useful efficiency | | | | |
| At rated heat output and high temperature regime | η_4 | % | 87.9 | 87.9 |
| At 30 % of rated heat output and low temperature regime | η_1 | % | 98.8 | 98.8 |
| Auxiliary electricity consumption | | | | |
| At full load | e_{max} | kW | 0.0370 | 0.0370 |
| At part load | e_{min} | kW | 0.0120 | 0.0120 |
| In standby mode | P_{SB} | kW | 0.0027 | 0.0027 |
| Other items | | | | |
| Standby heat loss | P_{stby} | kW | 0.055 | 0.055 |
| Ignition burner power consumption | P_{ign} | kW | – | – |
| Emissions of nitrogen oxides (only gas- or oil fired) | NO_x | mg/kWh | 40 | 40 |
| Annual energy consumption | Q_{HE} | kWh | 20.417 | 20.417 |
| Annual energy consumption | Q_{HE} | GJ | 73.5 | 73.5 |
| Sound power level, indoors | L_{WA} | dB | 47 | 47 |
| Additional data for combination heaters | | | | |
| Declared load profile | – | – | XL | XL |
| Water heating energy efficiency | η_{wh} | % | 84 | 84 |
| Water heating energy efficiency class | – | – | A | A |
| Daily electricity consumption (average climate conditions) | Q_{elec} | kWh | 0.155 | 0.158 |
| Annual electricity consumption | AEC | kWh | 34 | 35 |
| Daily fuel consumption | Q_{fuel} | kWh | 22.067 | 22.604 |
| Annual fuel consumption | AFC | GJ | 17 | 18 |
| Indication about ability working only during off-peak hours | – | – | ✗ | ✗ |
| Other load profiles | – | – | – | – |
| Standing loss | S | W | – | – |
| Storage volume | V | l | – | – |
| Non-solar storage volume (Vbu) | Vbu | l | – | – |

1) High-temperature regime means 60 °C return temperature at heater inlet and 80 °C feed temperature at heater outlet.

2) Low temperature means for condensing boilers 30 °C, for low-temperature boilers 37 °C and for other heaters 50 °C return temperature (at heater inlet).

Table 9 Product data on energy consumption Greenstar 2000

Liquid Gas appliances

| Product data | Symbol | Unit | 7 736 902 328 | 7 736 902 327 |
|---|--------------------|--------|-------------------|-------------------|
| Product type | – | – | GR2301iW 25 C LPG | GR2301iW 30 C LPG |
| Condensing boiler | – | – | ✓ | ✓ |
| Low temperature boiler | – | – | ✗ | ✗ |
| B1 boiler | – | – | ✗ | ✗ |
| Cogeneration space heater | – | – | ✗ | ✗ |
| Equipped with a supplementary heater? | – | – | – | – |
| Combination heater | – | – | ✓ | ✓ |
| Rated heat output | P_{rated} | kW | 24 | 24 |
| Seasonal space heating energy efficiency | η_s | % | 94.0 | 94.0 |
| Energy Efficiency Class | – | – | A | A |
| Useful heat output | | | | |
| At rated heat output and high temperature regime ¹⁾ | P_4 | kW | 24 | 24 |
| At 30 % of rated heat output and low temperature regime ²⁾ | P_1 | kW | 7.9 | 7.9 |
| Useful efficiency | | | | |
| At rated heat output and high temperature regime | η_4 | % | 89.6 | 89.6 |
| At 30 % of rated heat output and low temperature regime | η_1 | % | 98.5 | 98.5 |
| Auxiliary electricity consumption | | | | |
| At full load | e_{max} | kW | 0.0370 | 0.0370 |
| At part load | e_{min} | kW | 0.0120 | 0.0120 |
| In standby mode | P_{SB} | kW | 0.0027 | 0.0027 |
| Other items | | | | |
| Standby heat loss | P_{stby} | kW | 0.055 | 0.055 |
| Ignition burner power consumption | P_{ign} | kW | – | – |
| Emissions of nitrogen oxides (only gas- or oil fired) | NO_x | mg/kWh | 65 | 65 |
| Annual energy consumption | Q_{HE} | kWh | 20.417 | 20.417 |
| Annual energy consumption | Q_{HE} | GJ | 73.5 | 73.5 |
| Sound power level, indoors | L_{WA} | dB | 47 | 47 |
| Additional data for combination heaters | | | | |
| Declared load profile | – | – | XL | XL |
| Water heating energy efficiency | η_{wh} | % | 84 | 84 |
| Water heating energy efficiency class | – | – | A | A |
| Daily electricity consumption (average climate conditions) | Q_{elec} | kWh | 0.153 | 0.153 |
| Annual electricity consumption | AEC | kWh | 34 | 34 |
| Daily fuel consumption | Q_{fuel} | kWh | 22.394 | 22.023 |
| Annual fuel consumption | AFC | GJ | 18 | 17 |
| Indication about ability working only during off-peak hours | – | – | ✗ | ✗ |
| Other load profiles | – | – | – | – |
| Standing loss | S | W | – | – |
| Storage volume | V | l | – | – |
| Non-solar storage volume (Vbu) | Vbu | l | – | – |

1) High-temperature regime means 60 °C return temperature at heater inlet and 80 °C feed temperature at heater outlet.

2) Low temperature means for condensing boilers 30 °C, for low-temperature boilers 37 °C and for other heaters 50 °C return temperature (at heater inlet).

Table 10 Product data on energy consumption Greenstar 2000

13 Data Protection Notice



We, **Bosch Thermotechnology Ltd., Cotswold Way, Warndon, Worcester WR4 9SW, United Kingdom** process product and installation information, technical and connection data, communication data, product registration and client history data to provide product functionality (art. 6 (1) sentence 1 (b)

GDPR), to fulfil our duty of product surveillance and for product safety and security reasons (art. 6 (1) sentence 1 (f) GDPR), to safeguard our rights in connection with warranty and product registration questions (art. 6 (1) sentence 1 (f) GDPR) and to analyze the distribution of our products and to provide individualized information and offers related to the product (art. 6 (1) sentence 1 (f) GDPR). To provide services such as sales and marketing services, contract management, payment handling, programming, data hosting and hotline services we can commission and transfer data to external service providers and/or Bosch affiliated enterprises. In some cases, but only if appropriate data protection is ensured, personal data might be transferred to recipients located outside of the European Economic Area. Further information are provided on request. You can contact our Data Protection Officer under: Data Protection Officer, Information Security and Privacy (C/ISP), Robert Bosch GmbH, Postfach 30 02 20, 70442 Stuttgart, GERMANY.

You have the right to object, on grounds relating to your particular situation or where personal data are processed for direct marketing purposes, at any time to processing of your personal data which is based on art. 6 (1) sentence 1 (f) GDPR. To exercise your rights, please contact us via **privacy.ttg@bosch.com** To find further information, please follow the QR-Code.



TECHNICAL SUPPORT: 0330 123 3366
RENEWABLE SUPPORT: 0330 123 9229
CONTROLS AND CONNECTIVITY TEAM: 0330 123 3641
APPOINTMENTS: 0330 123 9339
SPARES: 0330 123 9779
LITERATURE: 0330 123 9119
TRAINING: 0330 123 0166
SALES: 0330 123 9669

Bosch Thermotechnology Ltd.
Cotswold Way, Warndon
Worcester WR4 9SW
United Kingdom
Tel. 0330 123 9559
worcester-bosch.co.uk

